

Article number: 4395000551

Description: Rota-fix shaft-hub connection F55x85
Stainless steel

Measures

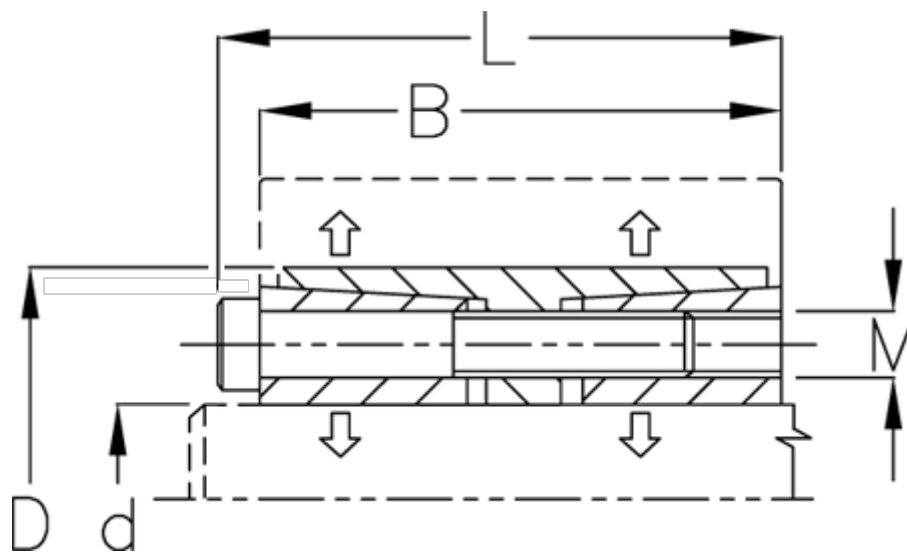

B mm	= 66
d H8 mm	= 55
D mm	= 85
Fit tolerance	= Aksel h8, Nav H8
F kN torque	= 98.7
L mm	= 74
M mm	= M8
P N/mm ² surface pressure on shaft/hub	= 34

Surface roughness	= R? ? 3.2 μm
T N m torque	= 2710
Ts N m bolt tightening torque	= 28.7